

HTD® s předvrtaným otvorem

5mm Rozteč 5M-25 (25mm šířka řemene)

Označení výrobku	Počet zubů	Typ	De	Dp	Df	Dm	F	L	d	Hmotnost kg
12-5M-25	12	S3F	18	19.10	23	13	31	36	6	0.05
14-5M-25	14	S3F	21	22.28	25	14	31	36	6	0.07
15-5M-25	15	S3F	23	23.87	28	16	31	36	6	0.08
16-5M-25	16	S3F	24	25.45	28	17	31	36	6	0.10
18-5M-25	18	S3F	28	28.65	32	20	31	36	6	0.12
20-5M-25	20	S3F	31	31.83	37	23	31	36	6	0.16
21-5M-25	21	S3F	32	33.42	38	24	31	38	6	0.19
22-5M-25	22	S3F	34	35.01	38	26	31	38	6	0.21
24-5M-25	24	S3F	37	38.20	43	27	31	38	6	0.25
26-5M-25	26	S3F	40	41.38	44	30	31	38	6	0.30
28-5M-25	28	S3F	43	44.56	48	31	31	38	6	0.35
30-5M-25	30	S3F	47	47.75	51	35	31	38	6	0.42
32-5M-25	32	S3F	50	50.93	54	38	31	38	8	0.48
36-5M-25	36	S3F	56	57.30	60	39	31	38	8	0.59
40-5M-25	40	S3F	63	63.66	70	38	31	38	8	0.74
44-5M-25	44	S3	69	70.03	-	38	31	40	8	0.32
48-5M-25	48	S3	75	76.39	-	38	31	40	8	0.28
60-5M-25	60	S3	94	95.49	-	50	31	40	8	0.44
72-5M-25	72	S3	113	114.59	-	50	31	40	8	0.53

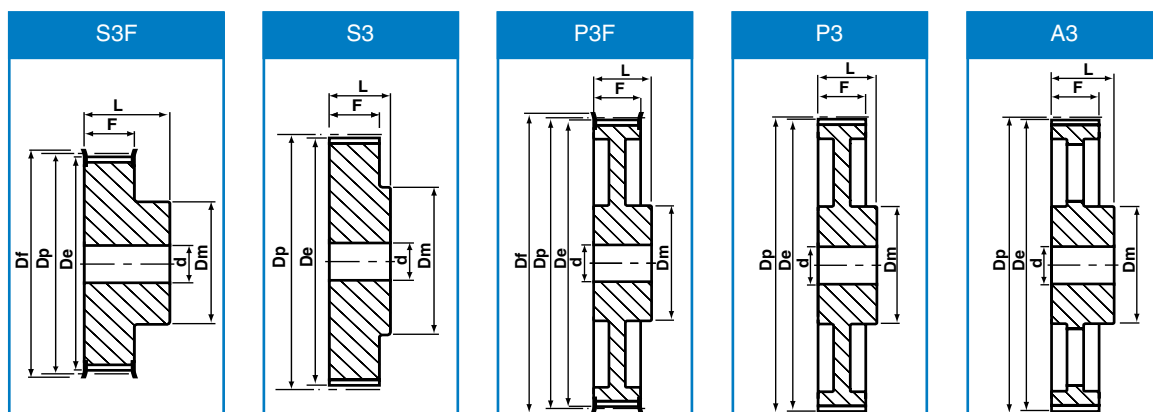

8mm Rozteč 8M-20 (20mm šířka řemene)

Označení výrobku	Počet zubů	Typ	De	Dp	Df	Dm	Di	F	L	d	Hmotnost kg
22-8M-20	22	S3F	55	56.02	60	43	-	28	38	12	0.54
24-8M-20	24	S3F	60	61.12	67	45	-	28	38	12	0.65
26-8M-20	26	S3F	65	66.21	70	50	-	28	38	12	0.80
28-8M-20	28	S3F	70	71.30	75	50	-	28	38	16	0.87
30-8M-20	30	S3F	75	76.39	83	55	-	28	38	16	1.02
32-8M-20	32	S3F	80	81.49	87	60	-	28	38	16	1.20
34-8M-20	34	S3F	85	86.58	91	70	-	28	38	16	1.40
36-8M-20	36	S3F	90	91.67	97	70	-	28	38	16	1.55
38-8M-20	38	S3F	95	96.77	102	75	-	28	38	16	1.65
40-8M-20	40	S3F	100	101.86	106	75	-	28	38	16	1.74
44-8M-20	44	S3F	111	112.05	120	75	-	28	38	16	2.10
48-8M-20	48	S3F	121	122.23	128	75	-	28	38	16	2.44
56-8M-20	56	P3F	141	142.60	150	80	117	28	38	16	2.60
64-8M-20	64	P3F	162	162.97	168	80	137	28	38	16	2.90
72-8M-20	72	P3F	182	183.35	192	80	158	28	38	16	3.10
80-8M-20	80	P3	202	203.72	-	90	180	28	38	16	3.80
90-8M-20	90	P3	228	229.18	-	90	204	28	38	16	4.20
112-8M-20	112	A3	284	285.21	-	90	260	28	38	16	5.20
144-8M-20	144	A3	365	366.69	-	90	341	28	38	20	7.50
168-8M-20	168	A3	426	427.81	-	100	402	28	38	20	10.00
192-8M-20	192	A3	488	488.92	-	100	463	28	38	20	14.40

Všechny rozměry jsou v milimetrech, pokud není uvedeno jinak.

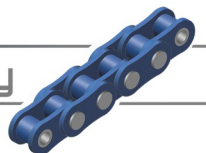

HTD® s předvrtaným otvorem

8mm Rozteč 8M-30 (30mm šířka řemene)

Označení výrobku	Počet zubů	Typ	De	Dp	Df	Dm	Di	F	L	d	Hmotnost kg
22-8M-30	22	S3F	55	56.02	60	43	-	38	48	12	0.69
24-8M-30	24	S3F	60	61.12	67	45	-	38	48	12	0.84
26-8M-30	26	S3F	65	66.21	70	50	-	38	48	12	1.00
28-8M-30	28	S3F	70	71.30	75	50	-	38	48	16	1.12
30-8M-30	30	S3F	75	76.39	83	55	-	38	48	16	1.32
32-8M-30	32	S3F	80	81.49	87	60	-	38	48	16	1.53
34-8M-30	34	S3F	85	86.58	91	70	-	38	48	16	1.80
36-8M-30	36	S3F	90	91.67	97	70	-	38	48	16	1.99
38-8M-30	38	S3F	95	96.77	102	75	-	38	48	16	2.27
40-8M-30	40	S3F	100	101.86	106	75	-	38	48	16	2.40
44-8M-30	44	S3F	111	112.05	120	75	-	38	48	16	2.80
48-8M-30	48	S3F	121	122.23	128	75	-	38	48	16	3.20
56-8M-30	56	P3F	141	142.60	150	80	117	38	48	16	3.60
64-8M-30	64	P3F	162	162.97	168	80	138	38	48	16	4.30
72-8M-30	72	P3F	182	183.35	192	80	158	38	48	16	4.80
80-8M-30	80	P3	202	203.72	-	90	180	38	48	16	5.10
90-8M-30	90	P3	228	229.18	-	90	204	38	48	16	5.70
112-8M-30	112	A3	284	285.21	-	90	260	38	48	16	6.80
144-8M-30	144	A3	365	366.69	-	90	341	38	48	20	9.30
168-8M-30	168	A3	426	427.81	-	100	402	38	48	20	11.40
192-8M-30	192	A3	488	488.92	-	100	463	38	48	20	16.00

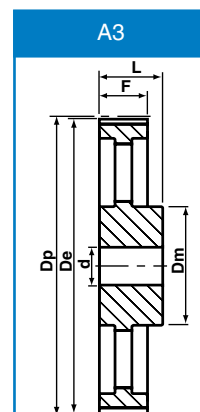
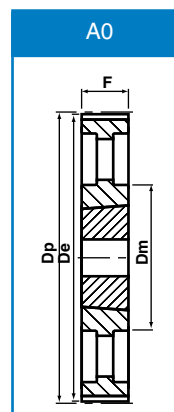
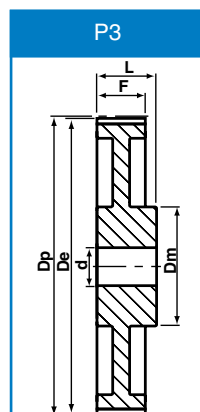
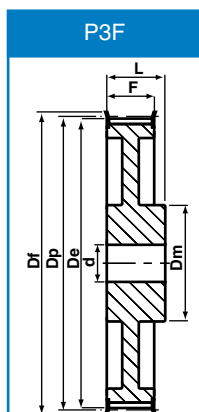
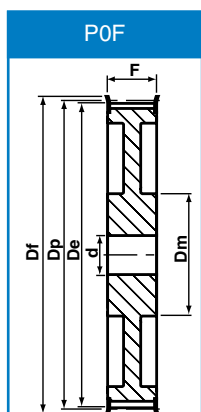
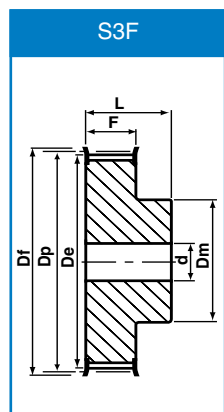

8mm Rozteč 8M-50 (50mm šířka řemene)

Označení výrobku	Počet zubů	Typ	De	Dp	Df	Dm	Di	F	L	d	Hmotnost kg
22-8M-50	22	S3F	55	56.02	60	43	-	60	70	12	1.00
24-8M-50	24	S3F	60	61.12	67	45	-	60	70	12	1.23
26-8M-50	26	S3F	65	66.21	70	50	-	60	70	12	1.50
28-8M-50	28	S3F	70	71.30	75	50	-	60	70	16	1.67
30-8M-50	30	S3F	75	76.39	83	55	-	60	70	16	1.97
32-8M-50	32	S3F	80	81.49	87	60	-	60	70	16	2.27
34-8M-50	34	S3F	85	86.58	91	70	-	60	70	16	2.69
36-8M-50	36	S3F	90	91.67	97	70	-	60	70	16	2.97
38-8M-50	38	S3F	95	96.77	102	75	-	60	70	16	3.23
40-8M-50	40	S3F	100	101.86	106	75	-	60	70	18	3.50
44-8M-50	44	S3F	111	112.05	120	75	-	60	70	18	3.90
48-8M-50	48	S3F	121	122.23	128	80	-	60	70	18	4.30
56-8M-50	56	P0F	141	142.60	150	90	117	60	60	18	5.00
64-8M-50	64	P0F	162	162.97	168	100	137	60	60	18	5.60
72-8M-50	72	P0F	182	183.35	192	100	158	60	60	18	6.80
80-8M-50	80	A0	202	203.72	-	110	180	60	60	18	6.90
90-8M-50	90	A0	228	229.18	-	110	204	60	60	18	8.60
112-8M-50	112	A0	284	285.21	-	110	260	60	60	18	9.60
144-8M-50	144	A0	365	366.69	-	110	341	60	60	20	13.80
168-8M-50	168	A0	426	427.81	-	120	402	60	60	20	16.00
192-8M-50	192	A0	488	488.92	-	130	463	60	60	20	22.40

Všechny rozměry jsou v milimetrech, pokud není uvedeno jinak.

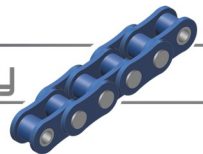

HTD® s předvrtaným otvorem

8mm Rozteč 8M-85 (85mm šířka řemene)

Označení výrobku	Počet zubů	Typ	De	Dp	Df	Dm	Di	F	L	d	Hmotnost kg
22-8M-85	22	S3F	55	56.02	60	43	-	95	105	12	1.55
24-8M-85	24	S3F	60	61.12	67	45	-	95	105	12	1.90
26-8M-85	26	S3F	65	66.21	70	50	-	95	105	12	2.25
28-8M-85	28	S3F	70	71.30	75	50	-	95	105	16	2.55
30-8M-85	30	S3F	75	76.39	83	55	-	95	105	16	3.00
32-8M-85	32	S3F	80	81.49	87	60	-	95	105	16	3.57
34-8M-85	34	S3F	85	86.58	91	70	-	95	105	16	4.00
36-8M-85	36	S3F	90	91.67	97	70	-	95	105	16	4.50
38-8M-85	38	S3F	95	96.77	102	75	-	95	105	16	4.90
40-8M-85	40	S3F	100	101.86	106	75	-	95	105	16	5.20
44-8M-85	44	S3F	111	112.05	120	75	-	95	105	18	6.60
48-8M-85	48	S3F	121	122.23	128	80	-	95	105	18	7.60
56-8M-85	56	S3F	141	142.60	150	90	-	95	105	18	9.80
64-8M-85	64	POF	162	162.97	168	100	137	95	95	20	10.40
72-8M-85	72	POF	182	183.35	192	100	158	95	95	20	11.40
80-8M-85	80	A0	202	203.72	-	110	180	95	95	20	13.20
90-8M-85	90	A0	228	229.18	-	110	204	95	95	20	16.30
112-8M-85	112	A0	284	285.21	-	110	260	95	95	25	21.50
144-8M-85	144	A0	365	366.69	-	110	341	95	95	25	23.60
168-8M-85	168	A0	426	427.81	-	120	402	95	95	25	26.10
192-8M-85	192	A0	488	488.92	-	130	463	95	95	25	30.60

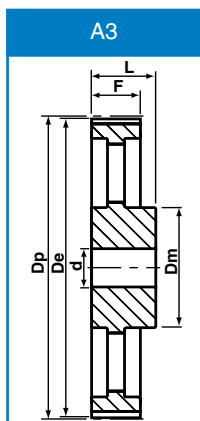
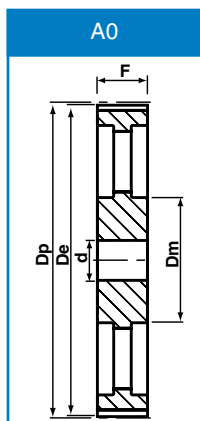
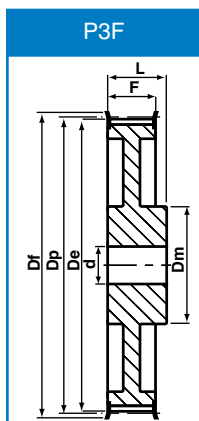
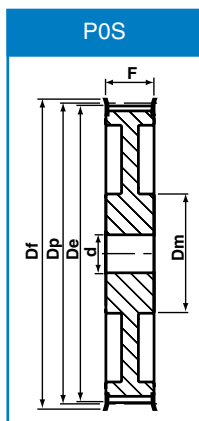
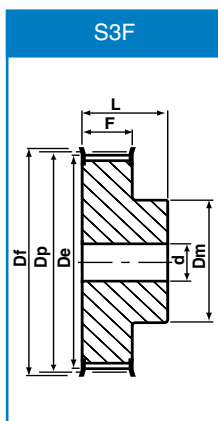

14mm Rozteč 14M-40 (40mm šířka řemene)

Označení výrobku	Počet zubů	Typ	De	Dp	Df	Dm	Di	F	L	d	Hmotnost kg
28-14M-40	28	S3F	122	124.78	128	100	-	54	69	24	4.73
29-14M-40	29	S3F	127	129.23	142	100	-	54	69	24	5.09
30-14M-40	30	S3F	131	133.69	142	100	-	54	69	24	5.45
32-14M-40	32	S3F	140	142.60	158	100	-	54	69	24	6.17
34-14M-40	34	S3F	149	151.52	158	100	-	54	69	24	6.88
36-14M-40	36	S3F	158	160.43	168	100	-	54	69	24	7.60
38-14M-40	38	S3F	167	169.34	184	120	-	54	69	24	8.28
40-14M-40	40	S3F	175	178.25	192	120	-	54	69	24	9.26
44-14M-40	44	S3F	193	196.08	211	120	-	54	69	24	10.32
48-14M-40	48	P3F	211	213.90	226	135	172	54	69	24	11.50
56-14M-40	56	P3F	247	249.55	265	135	207	54	69	28	13.05
64-14M-40	64	P3F	282	285.21	296	135	242	54	69	28	14.40
72-14M-40	72	A3	318	320.86	-	135	278	54	69	28	16.90
80-14M-40	80	A3	354	356.51	-	135	314	54	69	28	18.50
90-14M-40	90	A3	398	401.07	-	135	358	54	69	28	20.00
112-14M-40	112	A3	496	499.11	-	135	456	54	69	28	26.70
144-14M-40	144	A3	639	641.71	-	135	600	54	69	28	35.00
168-14M-40	168	A3	746	748.66	-	135	706	54	69	28	44.20
192-14M-40	192	A3	853	855.62	-	135	813	54	69	28	52.20
216-14M-40	216	A3	960	962.57	-	150	920	54	69	28	60.00

Všechny rozměry jsou v milimetrech, pokud není uvedeno jinak.

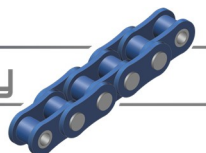

14mm Rozteč 14M-55 (55mm šířka řemene)

Označení výrobku	Počet zubů	Typ	De	Dp	Df	Dm	Di	F	L	d	Hmotnost kg
28-14M-55	28	S3F	122	124.78	128	100	-	70	85	24	5.60
29-14M-55	29	S3F	127	129.23	142	100	-	70	85	24	6.10
30-14M-55	30	S3F	131	133.69	142	100	-	70	85	24	6.60
32-14M-55	32	S3F	140	142.60	158	100	-	70	85	24	7.60
34-14M-55	34	S3F	149	151.52	158	100	-	70	85	24	8.60
36-14M-55	36	S3F	158	160.43	168	100	-	70	85	24	9.60
38-14M-55	38	S3F	167	169.34	184	120	-	70	85	24	10.80
40-14M-55	40	S3F	175	178.25	192	120	-	70	85	24	11.20
44-14M-55	44	S3F	193	196.08	211	120	-	70	85	24	12.50
48-14M-55	48	P0F	211	213.90	226	135	172	70	70	24	13.70
56-14M-55	56	P0F	247	249.55	265	135	207	70	70	28	14.50
64-14M-55	64	P0F	282	285.21	296	135	242	70	70	28	15.60
72-14M-55	72	A0	318	320.86	-	135	278	70	70	28	16.90
80-14M-55	80	A0	354	356.51	-	135	314	70	70	28	20.00
90-14M-55	90	A0	398	401.07	-	135	358	70	70	28	22.60
112-14M-55	112	A0	496	499.11	-	135	456	70	70	28	29.50
144-14M-55	144	A0	639	641.71	-	135	600	70	70	28	39.00
168-14M-55	168	A0	746	748.66	-	135	706	70	70	28	48.50
192-14M-55	192	A0	853	855.62	-	135	813	70	70	28	57.80
216-14M-55	216	A0	960	962.57	-	150	920	70	70	28	67.00

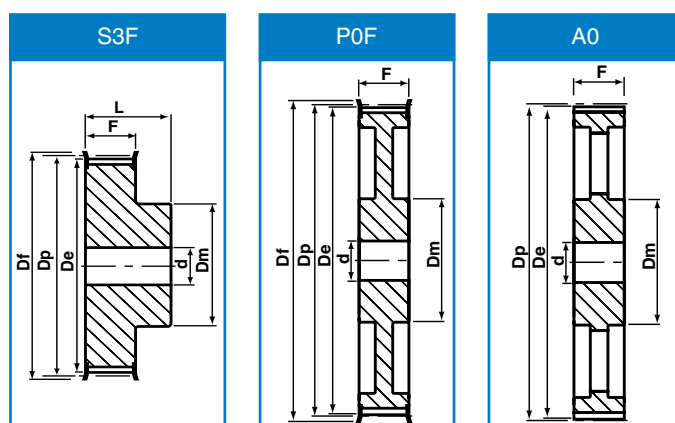

14mm Rozteč 14M-85 (85mm šířka řemene)

Označení výrobku	Počet zubů	Typ	De	Dp	Df	Dm	Di	F	L	d	Hmotnost kg
28-14M-85	28	S3F	122	124.78	128	100	-	102	117	24	7.70
29-14M-85	29	S3F	127	129.23	142	100	-	102	117	24	8.40
30-14M-85	30	S3F	131	133.69	142	100	-	102	117	24	9.10
32-14M-85	32	S3F	140	142.60	158	100	-	102	117	24	10.50
34-14M-85	34	S3F	149	151.52	158	100	-	102	117	24	11.90
36-14M-85	36	S3F	158	160.43	168	100	-	102	117	32	13.20
38-14M-85	38	S3F	167	169.34	184	120	-	102	117	32	15.15
40-14M-85	40	S3F	175	178.25	192	135	-	102	117	32	17.10
44-14M-85	44	S3F	193	196.08	211	135	-	102	117	32	23.30
48-14M-85	48	S3F	211	213.90	226	150	-	102	117	32	25.00
56-14M-85	56	P0F	249	249.55	265	150	207	102	102	32	25.00
64-14M-85	64	P0F	282	285.21	296	150	242	102	102	32	30.50
72-14M-85	72	A0	318	320.86	-	150	278	102	102	32	28.80
80-14M-85	80	A0	354	356.51	-	150	314	102	102	32	30.10
90-14M-85	90	A0	398	401.07	-	150	358	102	102	32	33.00
112-14M-85	112	A0	496	499.11	-	150	456	102	102	32	41.80
144-14M-85	144	A0	639	641.71	-	150	600	102	102	32	52.40
168-14M-85	168	A0	746	748.66	-	150	706	102	102	32	60.30
192-14M-85	192	A0	853	855.62	-	165	813	102	102	32	70.20
216-14M-85	216	A0	960	962.57	-	165	920	102	102	32	81.00

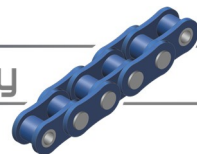

HTD® s předvrtaným otvorem

14mm Rozteč 14M-115 (115mm šířka řemene)

Označení výrobku	Počet zubů	Typ	De	Dp	Df	Dm	Di	F	L	d	Hmotnost kg
28-14M-115	28	S3F	122	124.78	128	100	-	133	148	32	9.20
29-14M-115	29	S3F	127	129.23	142	100	-	133	148	32	10.20
30-14M-115	30	S3F	131	133.69	142	100	-	133	148	32	11.20
32-14M-115	32	S3F	140	142.60	158	100	-	133	148	32	13.20
34-14M-115	34	S3F	149	151.52	158	100	-	133	148	32	14.80
36-14M-115	36	S3F	158	160.43	168	100	-	133	148	32	16.60
38-14M-115	38	S3F	167	169.34	184	120	-	133	148	32	19.20
40-14M-115	40	S3F	175	178.25	192	135	-	133	148	32	20.56
44-14M-115	44	S3F	193	196.08	211	140	-	133	148	32	21.93
48-14M-115	48	S3F	211	213.90	226	150	-	133	148	32	25.00
56-14M-115	56	S3F	247	249.55	265	150	-	133	148	32	27.50
64-14M-115	64	P0F	282	285.21	296	150	242	133	133	32	30.10
72-14M-115	72	A0	318	320.86	-	150	278	133	133	32	32.83
80-14M-115	80	A0	354	356.51	-	150	314	133	133	32	35.55
90-14M-115	90	A0	399	401.07	-	150	358	133	133	32	41.00
112-14M-115	112	A0	496	499.11	-	150	456	133	133	32	54.40
144-14M-115	144	A0	639	641.71	-	165	600	133	133	32	67.80
168-14M-115	168	A0	746	748.66	-	165	706	133	133	32	75.80
192-14M-115	192	A0	853	855.62	-	165	813	133	133	32	88.30
216-14M-115	216	A0	960	962.57	-	165	920	133	133	32	98.00

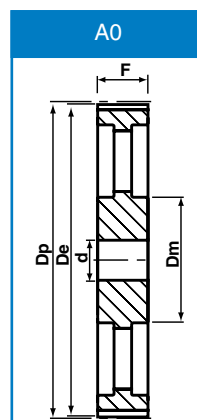
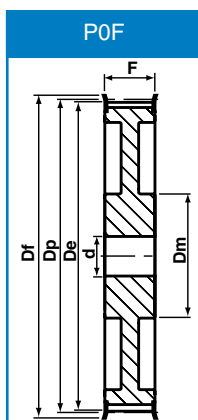
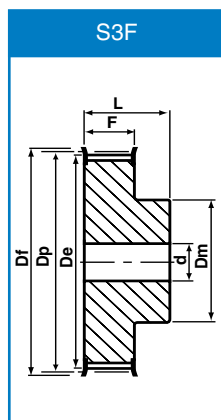

14mm Rozteč 14M-170 (170mm šířka řemene)

Označení výrobku	Počet zubů	Typ	De	Dp	Df	Dm	Di	F	L	d	Hmotnost kg
28-14M-170	28	S3F	122	124.78	128	100	-	187	202	32	13.80
29-14M-170	29	S3F	127	129.23	142	100	-	187	202	32	14.20
30-14M-170	30	S3F	131	133.69	142	100	-	187	202	32	15.60
32-14M-170	32	S3F	140	142.60	158	100	-	187	202	32	18.10
34-14M-170	34	S3F	149	151.52	158	100	-	187	202	32	20.40
36-14M-170	36	S3F	158	160.43	168	120	-	187	202	32	23.50
38-14M-170	38	S3F	167	169.34	184	135	-	187	202	32	26.50
40-14M-170	40	S3F	175	178.25	192	135	-	187	202	32	30.10
44-14M-170	44	S3F	193	196.08	211	160	-	187	202	32	37.80
48-14M-170	48	S3F	211	213.90	226	160	-	187	202	32	44.50
56-14M-170	56	S3F	247	249.55	265	160	-	187	202	32	61.00
64-14M-170	64	S3F	282	285.21	296	180	-	187	202	32	81.00
72-14M-170	72	A0	318	320.86	-	180	278	187	187	32	61.40
80-14M-170	80	A0	354	356.51	-	180	314	187	187	32	65.00
90-14M-170	90	A0	398	401.07	-	180	358	187	187	38	68.00
112-14M-170	112	A0	496	499.11	-	200	456	187	187	38	87.50
144-14M-170	144	A0	639	641.71	-	220	600	187	187	38	114.00
168-14M-170	168	A0	746	748.66	-	220	706	187	187	38	125.00
192-14M-170	192	A0	853	855.62	-	220	813	187	187	38	136.40
216-14M-170	216	A0	960	962.57	-	220	920	187	187	38	147.00

Všechny rozměry jsou v milimetrech, pokud není uvedeno jinak.